

*American Standard*

# Ultima™ Manual Urinal Flush Valve, Piston-Type 3/4" Top Spud, 1.0 gpf

MODEL NUMBERS

**6045.101**

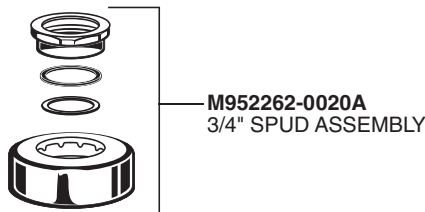
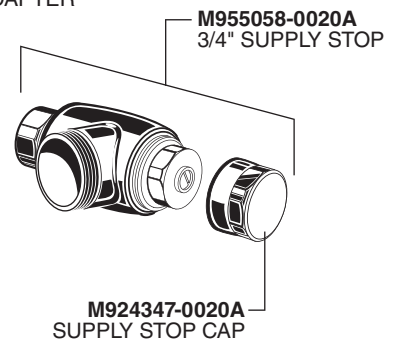
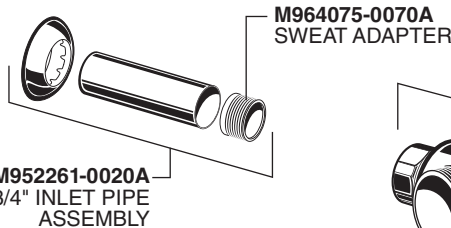
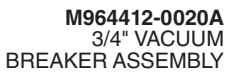
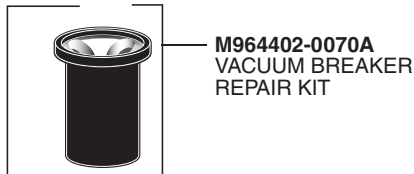
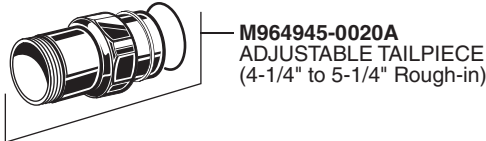
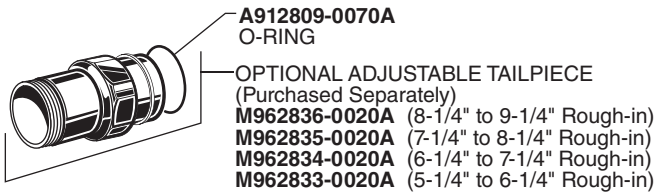
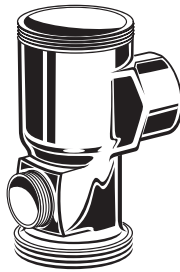
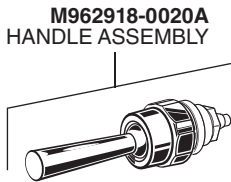
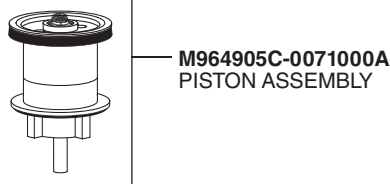
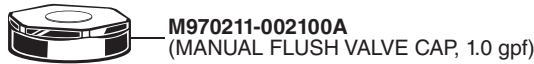

PART OF **LIXIL**



HOT LINE FOR HELP  
For toll-free information and answers to your questions, call:  
(844) CRT-TEAM / (844) 278-8326  
Weekdays 8:00 a.m. to 6:00 p.m. EST  
IN MEXICO 01-800-839-1200  
IN CANADA 1-800-387-0369 (TORONTO 1-905-306-1093)  
Weekdays 8:00 a.m. to 7:00 p.m. EST

Product names listed herein are trademarks of AS America, Inc. ©2019

To learn more about American Standard Selectronic® Products visit our website at:  
[www.americanstandard-us.com](http://www.americanstandard-us.com) or e-mail us at: [CRTTEAM@lixilamericas.com](mailto:CRTTEAM@lixilamericas.com)