

**INSTALLATION
INSTRUCTIONS**

**4968.410
4968.415**

**ESTATE®
PULL-DOWN BAR**

Thank you for selecting American Standard...
the benchmark of fine quality for over 100 years.

To ensure that your installation proceeds smoothly-please read
these instructions carefully before you begin.

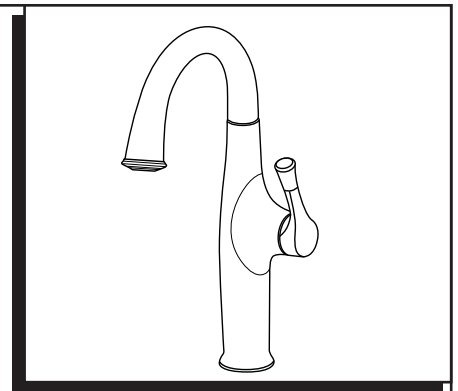

Certified to comply with ANSI A112.18.1M

RECOMMENDED TOOLS



Flat Blade Screwdriver



Phillips Screwdriver



Adjustable Wrench

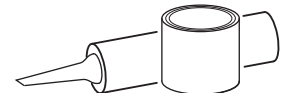

Plumbers' Putty or Caulking

1 INSTALL FAUCET WITH OR WITHOUT DECK ESCUTCHEON

CAUTION Turn off hot and cold water supplies before beginning.

- **(A) Installation less ESCUTCHEON (1).** Make certain the SEAL (9) is properly seated in recess of faucet body. Insert supply HOSES (2), SPRAY HOSE (7) and SHANK (3) through mounting hole and seat SPOUT BASE onto sink or mounting surface. Do not use putty.
- **(B) Installation with ESCUTCHEON (1 Optional).** Apply a bead of putty to bottom edge of ESCUTCHEON with PUTTY PLATE (1). Make certain the SEAL (9) is properly seated in recess of faucet body. Insert SUPPLY HOSES (2), SPRAY HOSE (7) and SHANK (3) through hole of ESCUTCHEON with PUTTY PLATE (1) and mounting surface. Follow mounting instructions below to secure faucet to mounting surface.
- Insert HOSES (2) through RUBBER WASHER (4), BRASS WASHER (5), and threaded LOCKNUT (6).
- Assemble RUBBER WASHER (4), BRASS WASHER (5), and threaded LOCKNUT (6) onto SHANK (3) from underside of sink or mounting surface. Hand tighten LOCKNUT (6).
- Use a screwdriver to tighten SCREWS (8) on LOCKNUT (6). Work your way around LOCKNUT (6), tightening the screws slightly each time until all are snug to ensure even pressure.

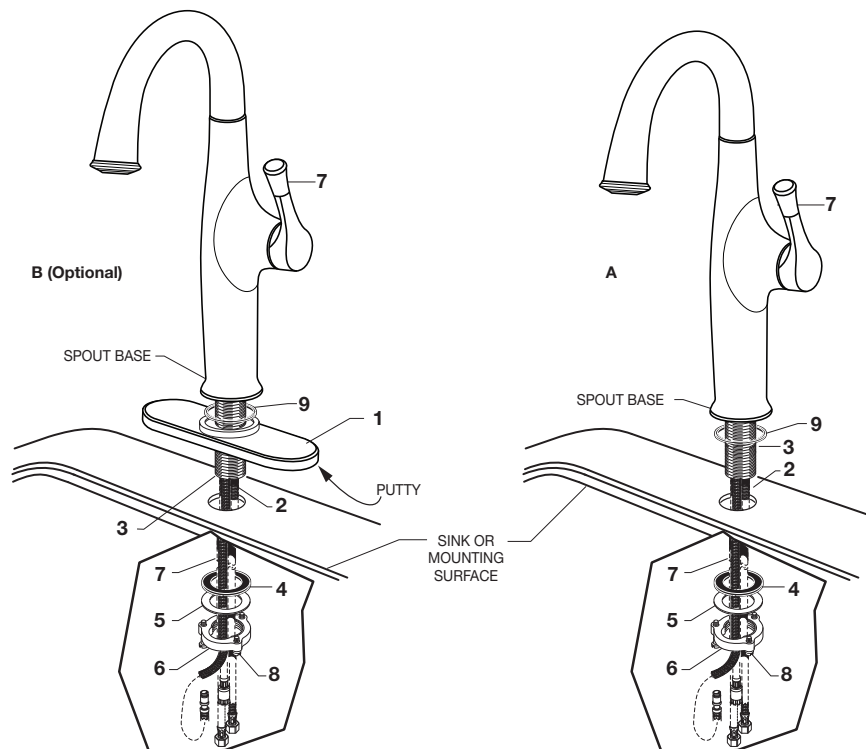

2 MAKE WATER SUPPLY CONNECTIONS

- Turn off hot and cold water supplies before beginning.
- Connect FLEXIBLE SUPPLY HOSES (1, 2) directly to wall supplies. Connection on fitting supplies are 3/8" compression. Connect left supply hose (Red Stripe) to Hot wall supply. Connect right supply hose (Blue Stripe) to Cold wall supply. Use adjustable wrench to tighten connections. Do not over tighten.

* Faucet supplies are 32" long from faucet base.

• **Note:** If additional supply length is required, installer must purchase additional parts separately.

• **Important:** If SUPPLY HOSES (1, 2) are too long, loop as illustrated to avoid kinking.

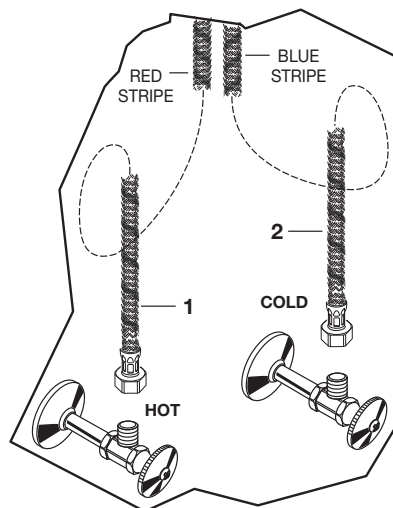

3 CONNECT SPRAY HOSE AND INSTALL WEIGHTS

- Push the SPRAY HOSE END (1) into the HOSE CONNECTOR (2) and slide down the LOCKING COLLAR (3) until it snaps into place.
- With HAND SPRAY (4) seated in SPOUT (5), install WEIGHT (6) at labeled area on HOSE (7), secure with SCREW (8).
- Adding SECOND WEIGHT (9) is optional.
- With one weight, spray will retract and dock potentially requiring slight assistance.
- With two weights, spray will retract and dock automatically once released.
- Please add the SECOND WEIGHT (9) above the initial WEIGHT (6).

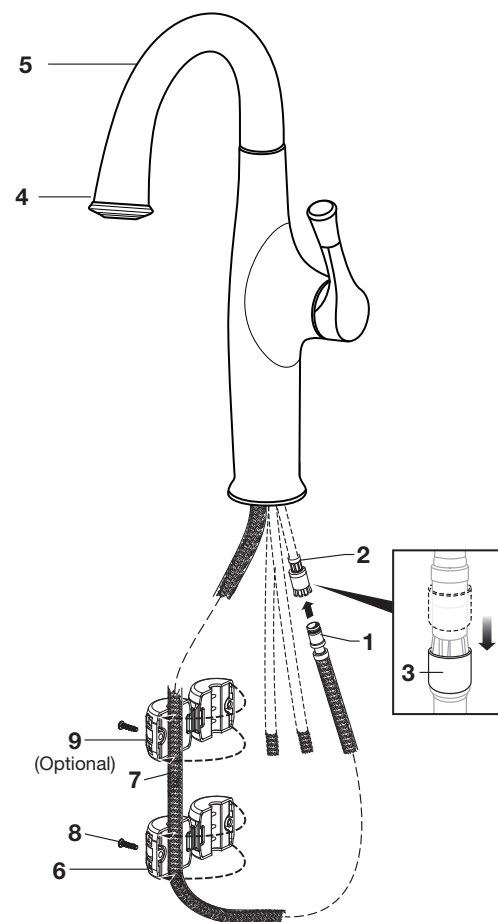

4 TEST INSTALLED FAUCET

- Turn ON water at main supply.
- With HANDLE (1) in "off" position, unthread SPRAY (3) from HOSE (2).
- Operate handle back to front, in COLD and HOT positions, to flush water lines thoroughly.
- Replace SPRAY (3) onto HOSE (2).

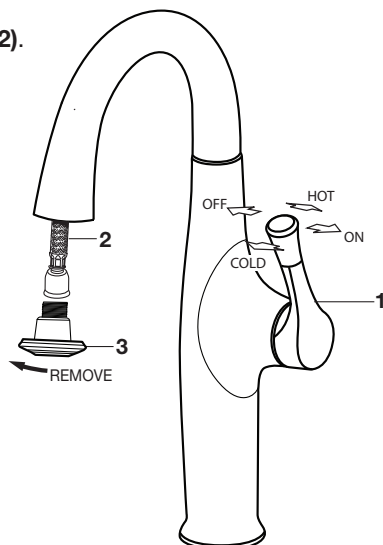

5 CHECK CONNECTIONS FOR LEAKS

- Move HANDLE (1) into "off" position.
- Turn on water supplies and check connections for leaks. ➡
- Operate HANDLE (2) up and down, left and right to flush water lines thoroughly.
- Operate HAND SPRAY and check connections for leaks. ➡

CHECK CONNECTIONS
FOR LEAKS ➡

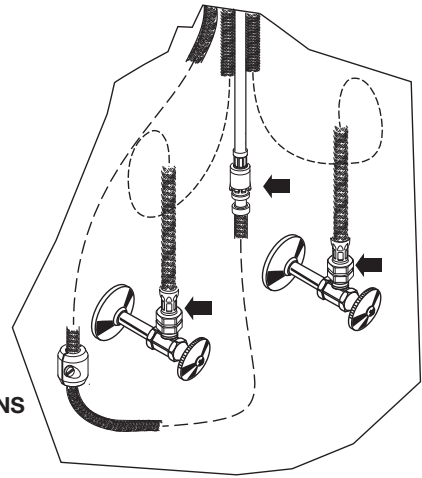

6 SERVICE

If Faucet Drips, Proceed As Follows:

- Turn VALVE to OFF position.
- Operate HANDLE several times from OFF to ON position. Do not apply excessive force.

Reduced Flow:

- Clean out spray head screen.
- Clean out cartridge.

Clogged CARTRIDGE outlets or inlets may cause reduced flow.

To clean, first turn off water supply then:

- Loosen HANDLE SCREW (1) and remove HANDLE (2).
- Unthread ESCUTCHEON CAP (3). Unthread three MOUNTING SCREWS (4).
- Lift CARTRIDGE (5) off MANIFOLD (6) and remove CARTRIDGE SEALS (7).
- Clean MANIFOLD (6), CARTRIDGE (5) ports and SEALS (7).
- Place SEALS (7) into CARTRIDGE PORTS (5a).
- Place CARTRIDGE (5) onto MANIFOLD (6) and tighten MOUNTING SCREWS (4) alternately.
- Replace ESCUTCHEON CAP (4), HANDLE (2), tighten HANDLE SCREW (1).

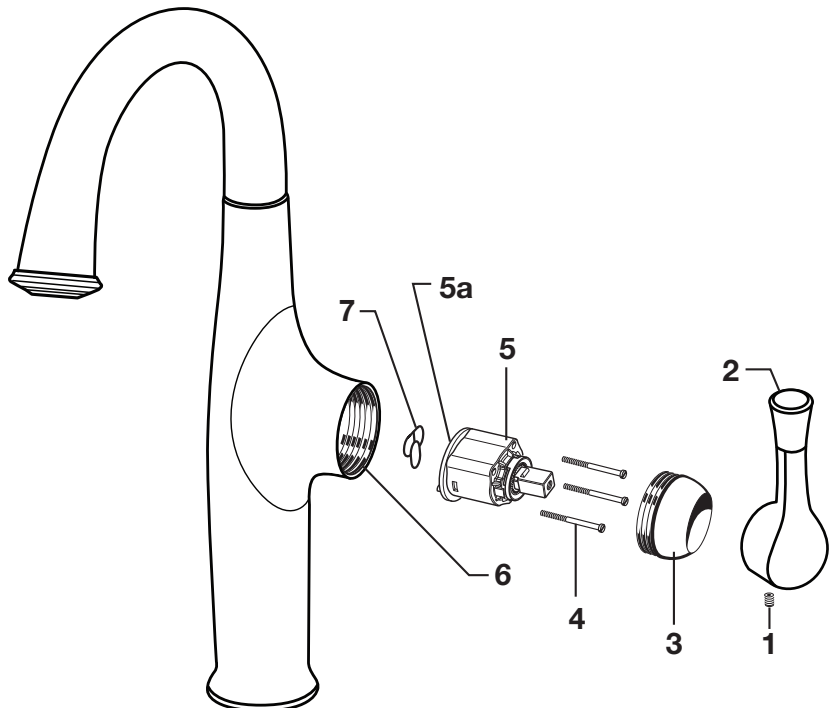

7 CARE INSTRUCTIONS:

DO: CLEAN WITH CLEAR WATER. DRY WITH A SOFT COTTON FLANNEL CLOTH.

DO NOT: DO NOT CLEAN THE PRODUCT WITH SOAPS, ACID, POLISH, ABRASIVES, HARSH CLEANERS, OR A CLOTH WITH A COARSE SURFACE.

8 PROBLEM

SOLUTION

Hose doesn't retract

Make sure the hose is not tangled up under the sink. Try to correct it by spinning the spout 360°.

Hose doesn't fully dock to spout

Add Optional weight (as mentioned in section 3).

9 HOSE KIT INSTALLATION

- This section gives guidance in installing replacement hose.
- Make sure that the old hose has been pulled out completely before installing a new one.
- Install the CONE (1) onto HOSE (2) by threading it on clock wise.
- Push the hose through the body and out from the other side with cone side going first (3).
- Unthread the cone by rotating it counter-clock wise.
- Install the SPOUT HEAD (4) back onto the hose by threading it onto the adapter clockwise.

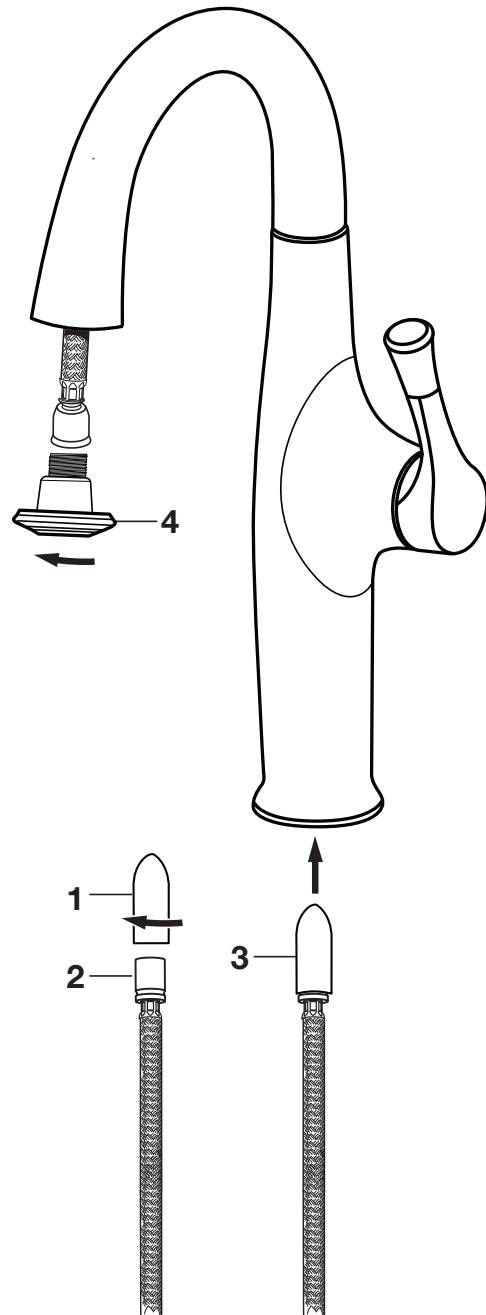

American Standard

ESTATE® KITCHEN BAR

MODEL NUMBER

4968.410

4968.415

ONLY INCLUDED WHEN HOSE IS
PURCHASED FOR REPLACEMENT

M950415-0070A
Spray Hose Assembly

M911781-YYY0A
Spray Assembly

M951483-0070A
Cartridge

M918511-0070A
Cartridge Screws

M907315-YYY0A
Escutcheon Cap

M970068-YYY0A
Handle Kit

M964762-YYY0A
Button & Screw Kit

A911836-0070A
Seal

2064101P-YYY
Escutcheon & Putty Plate
(Optional / Sold Separately)

M962146-0070A
Mounting Kit

Replace the "YYY" with
appropriate finish code

POLISHED CHROME	002
LEGACY BRONZE	278
STAINLESS STEEL	075

M964395-0070A
Weight

M964395-0070A
Weight
(Optional)

HOT LINE FOR HELP

For toll-free information and answers to your questions, call:
1 (800) 442-1902

Mon. - Fri. 8:00 a.m. to 8:00 p.m. EST

Saturday 10:00 a.m. to 4:00 p.m. EST

IN CANADA 1-800-387-0369

(TORONTO 1-905-306-1093)

Weekdays 8:00 a.m. to 7:00 p.m. EST

IN MEXICO 01-800-839-1200



PART OF LIXIL